

Woven Heart Basket

Supplies

- Construction paper or felt in two different colors
- Scissors
- Ribbon or string for hanging the basket
- Optional: hole puncher

Steps

- 1 Cut the paper as shown below to create 2 oval shapes.
- 2 Gently fold each piece in half. Do NOT sharply crease the fold edge.
- 3 Cut three equally spaced slice cuts in each shape.
- 4 Position folded pieces so curves face up and to either side.
- 5 Weave the strips together by alternating between the loops going through or around one another.
- 6 Once one row is down, shift it upwards and do the next strip.
- 7 Repeat until all the strips are woven together.
- 8 Poke holes and string for hanging.

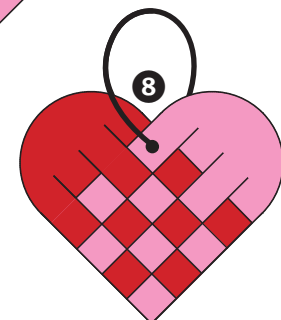
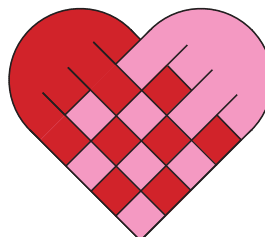
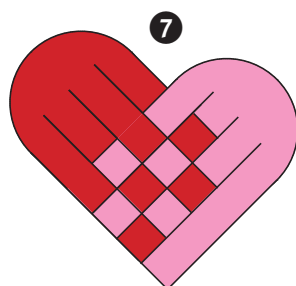
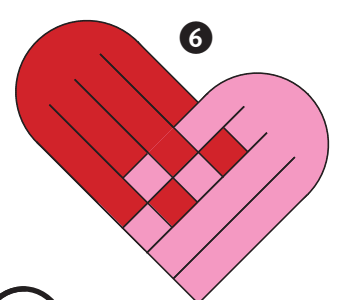
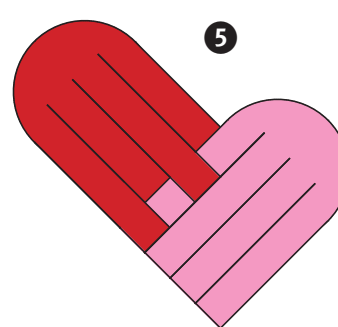
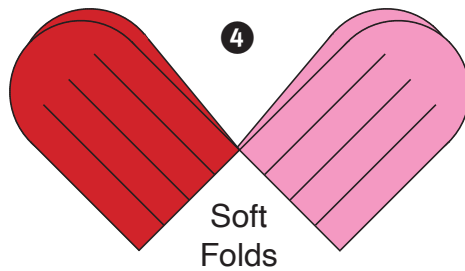
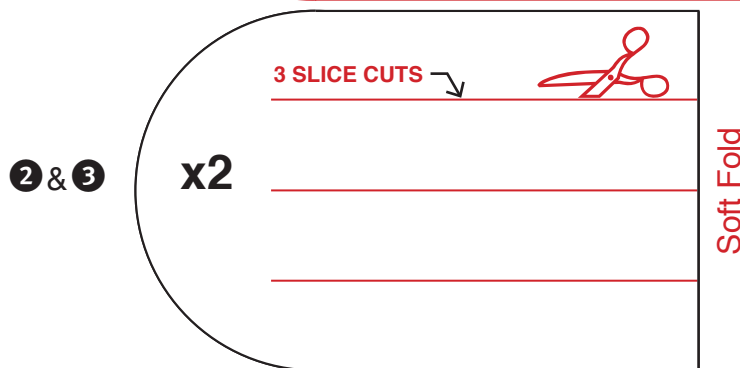
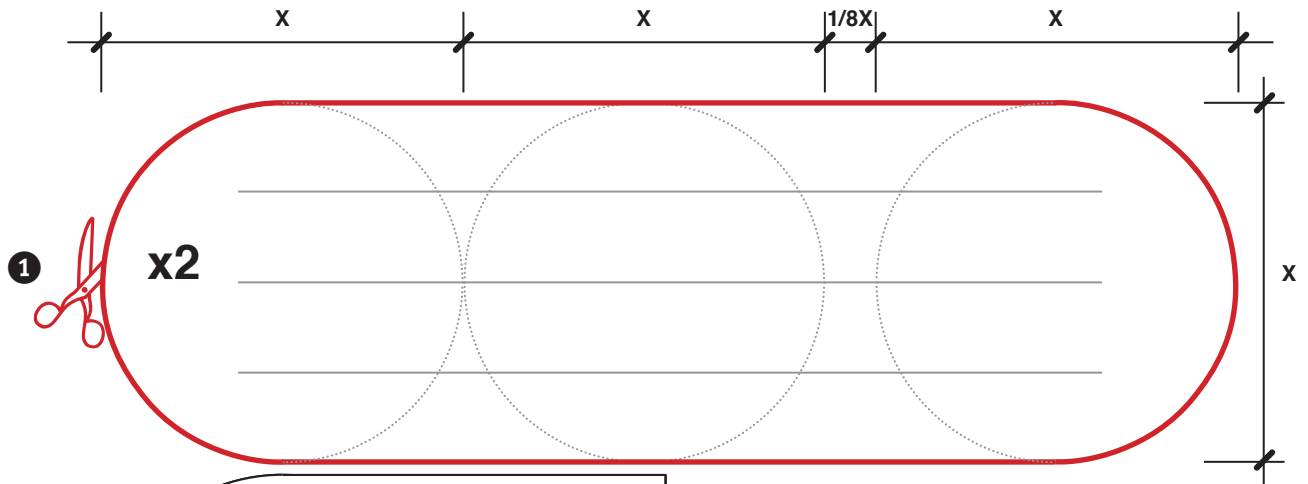

Woven Heart Basket Template

For the checkerboard look, make each shape a different color. For added fun, add doodles!

